

Intruder Alert Safety

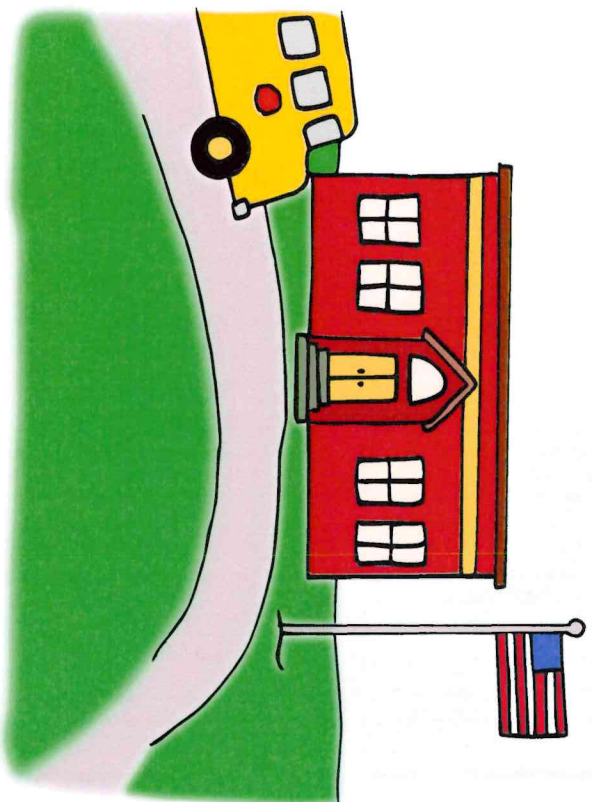

**We can stay safe at
our school.**



We practice safety drills so we know what to do when it is unsafe.

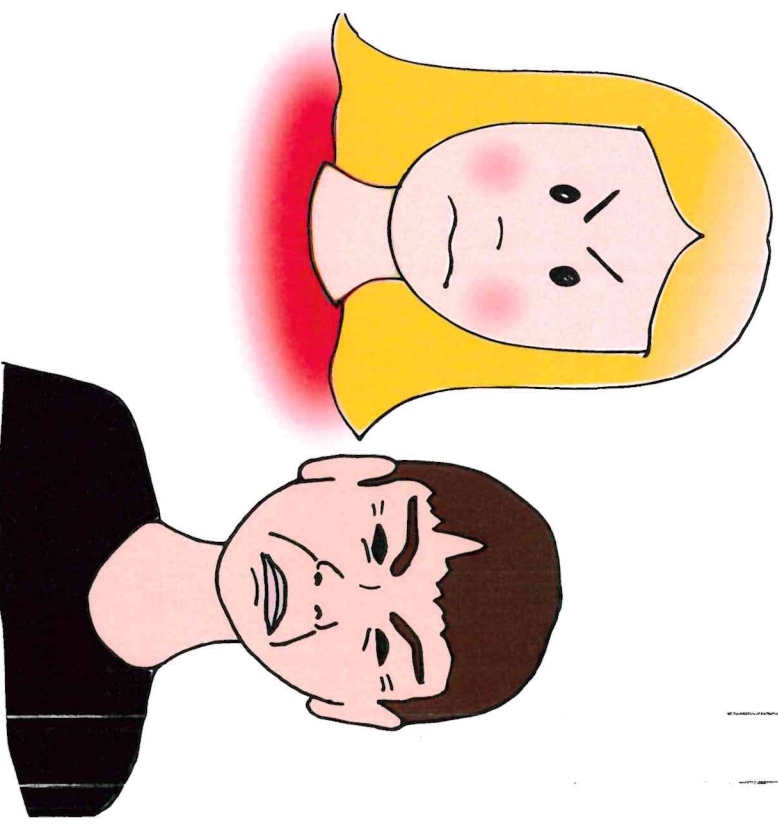

If there are unsafe strangers in our school, we will have an intruder alert.

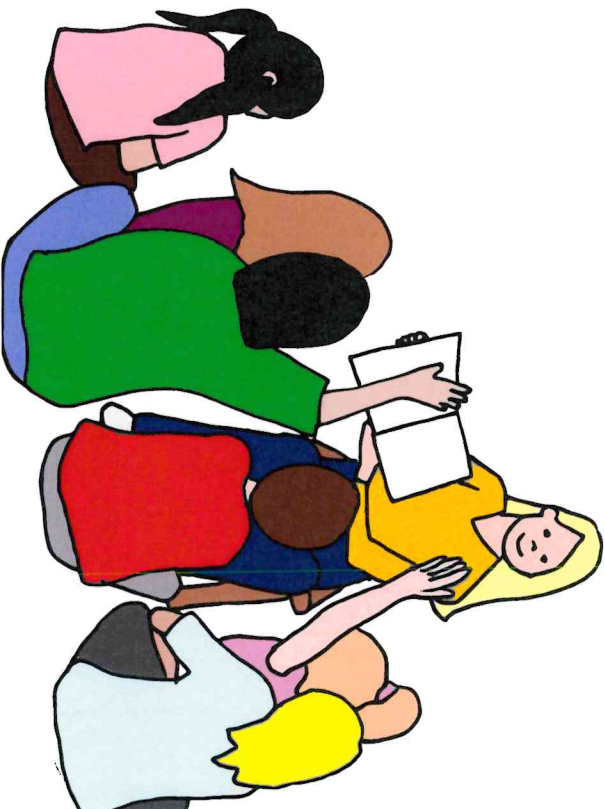

When there's an
intruder alert, we will
hear a really loud alarm.

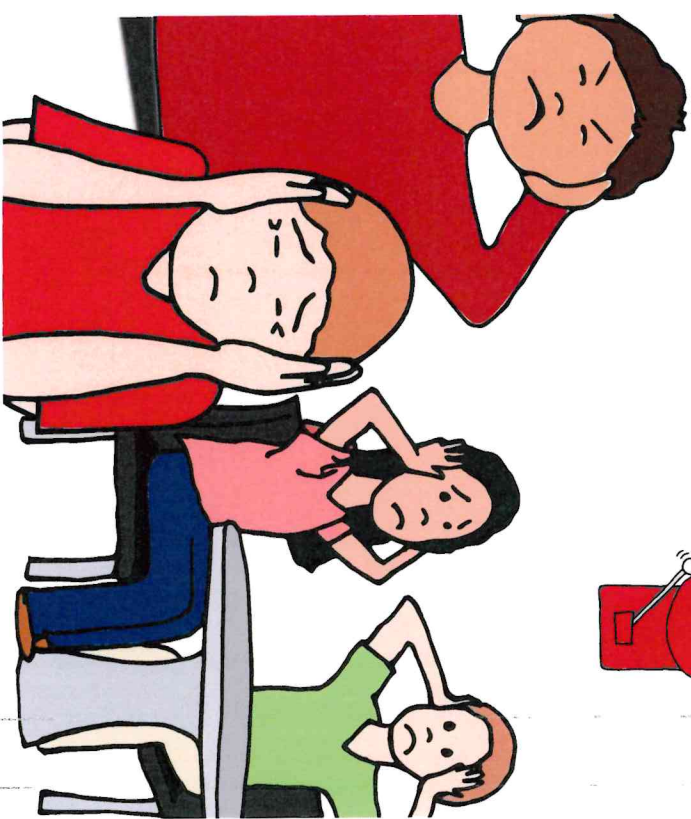
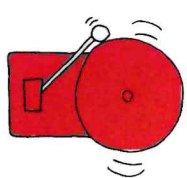

There will also be a loud
voice saying, "Intruder
Alert!"



*We need to stay calm;
it is not okay to scream
or yell.*

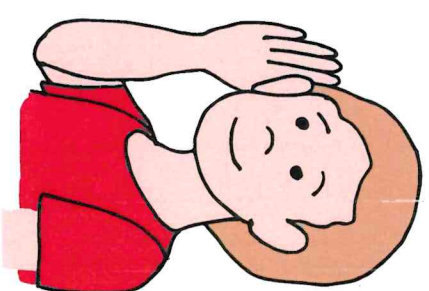
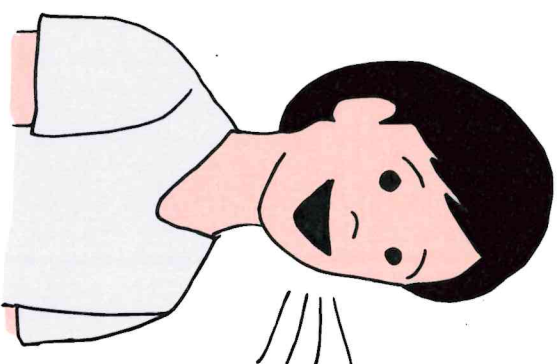

*We should listen to our
teacher and follow their
directions.*

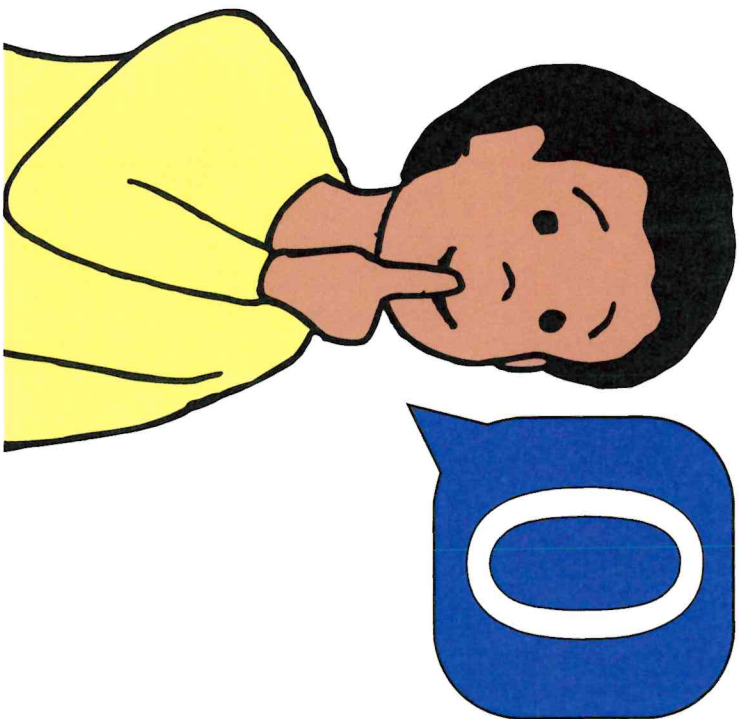

Our voices should be at
a level zero.



If we are in MAPE, we
will listen to our MAPE
teachers.

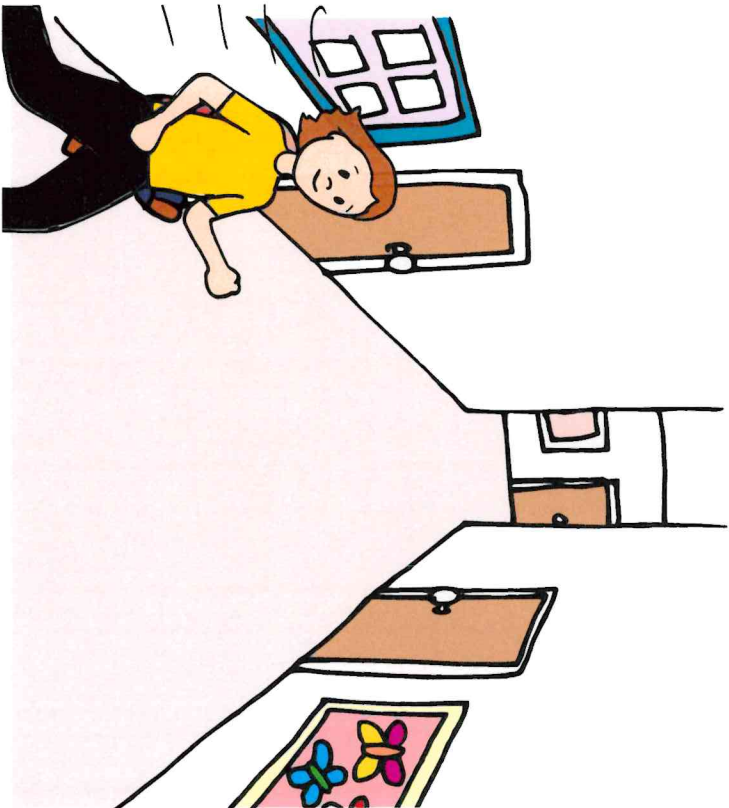

If we are in the halls,
we should run into the
closest classroom.

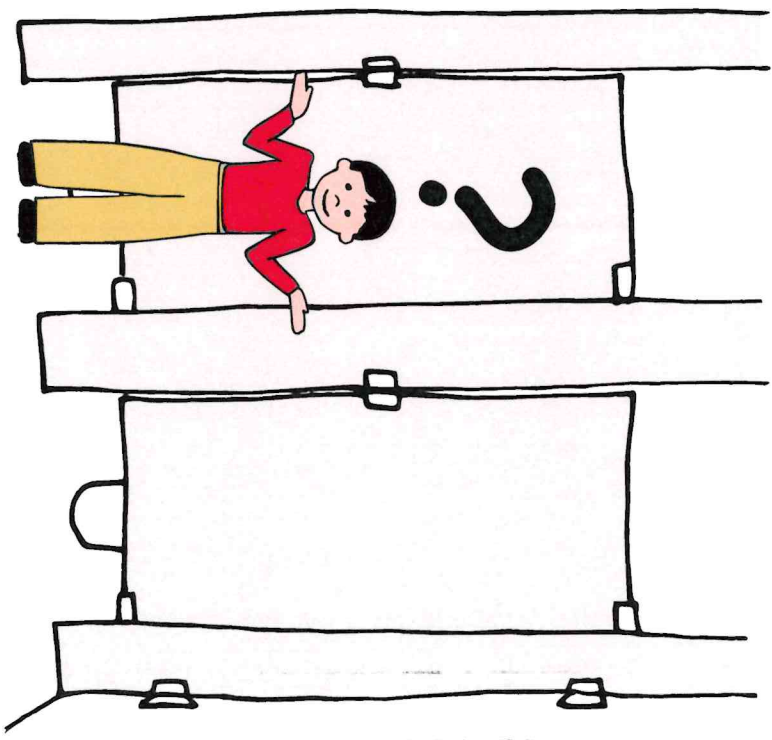

If we are in the
bathroom, we can stay
there to hide.

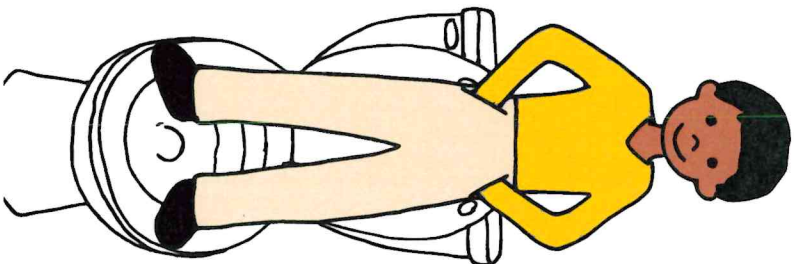
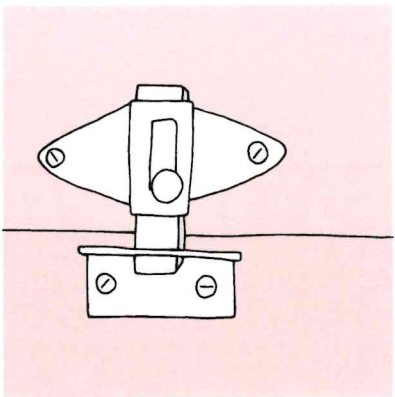

We should lock the stall
door and stand on the
toilet.

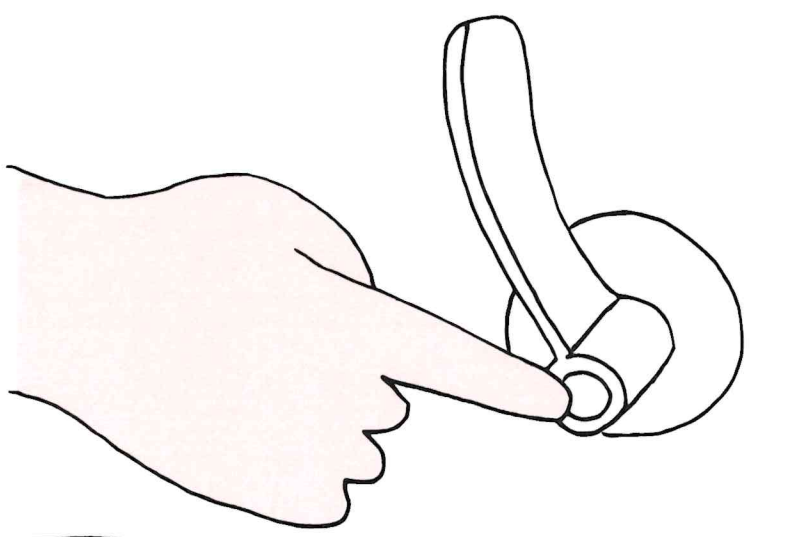

In our classroom, we will
lock the door.

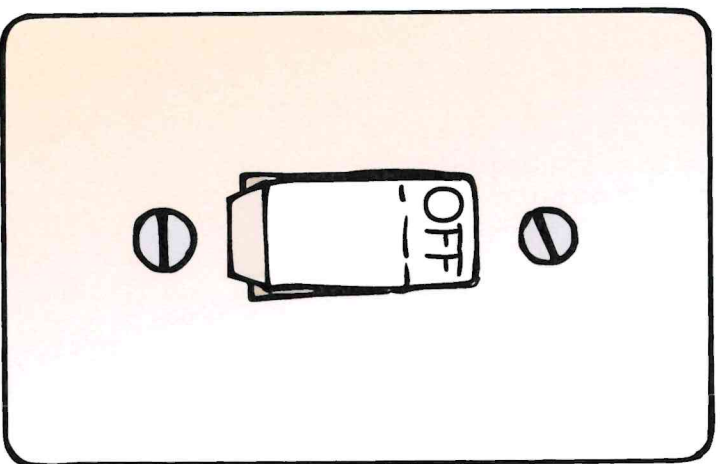

We will also turn the
lights off.

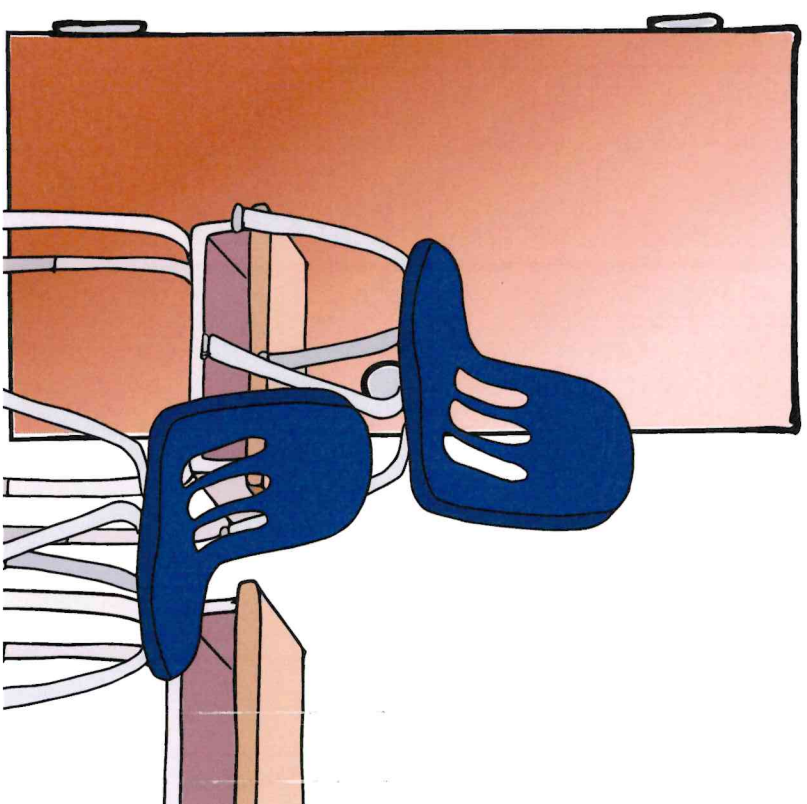

We can block the door
with desks and chairs.

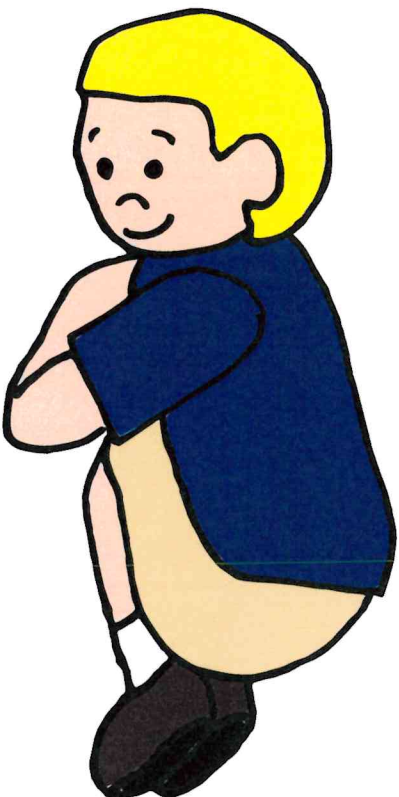

We can crouch on the ground to stay safe.

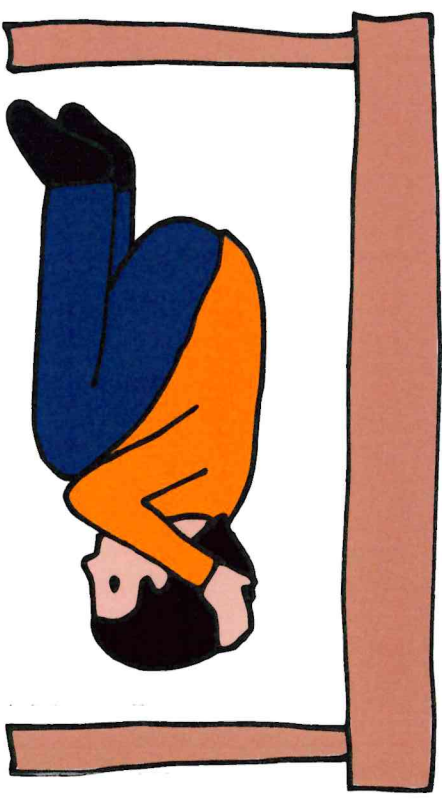

Sometimes our teacher might have us go under a table.

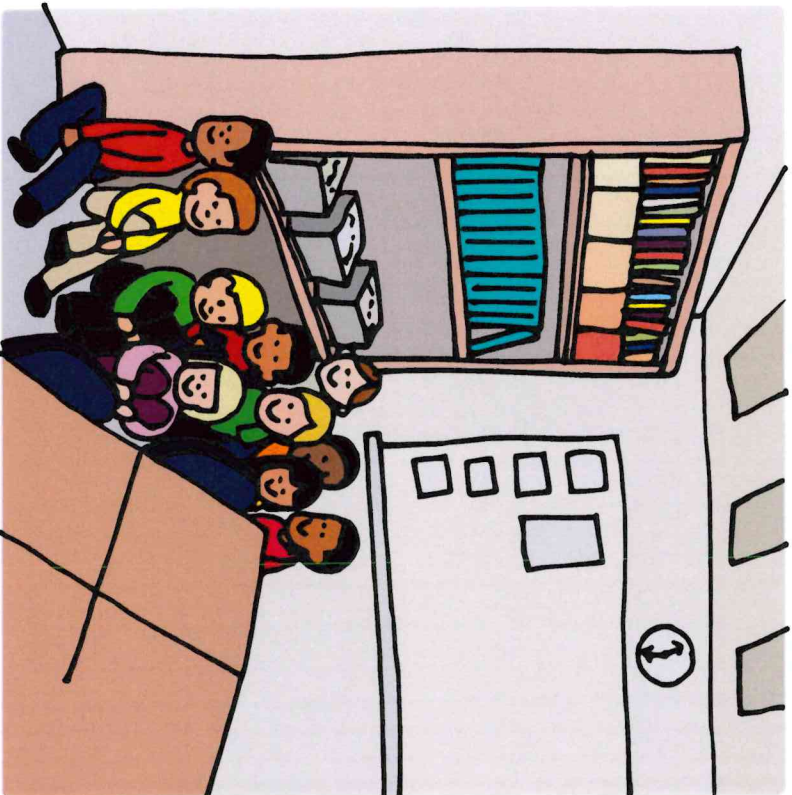

This is how we stay safe during an intruder alert. It keeps us safe from unsafe strangers.

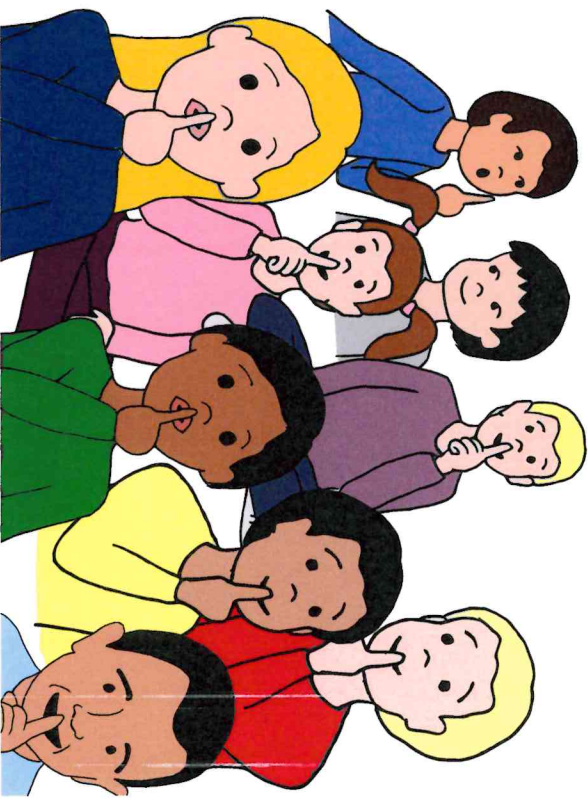

We need to be quiet the whole time.

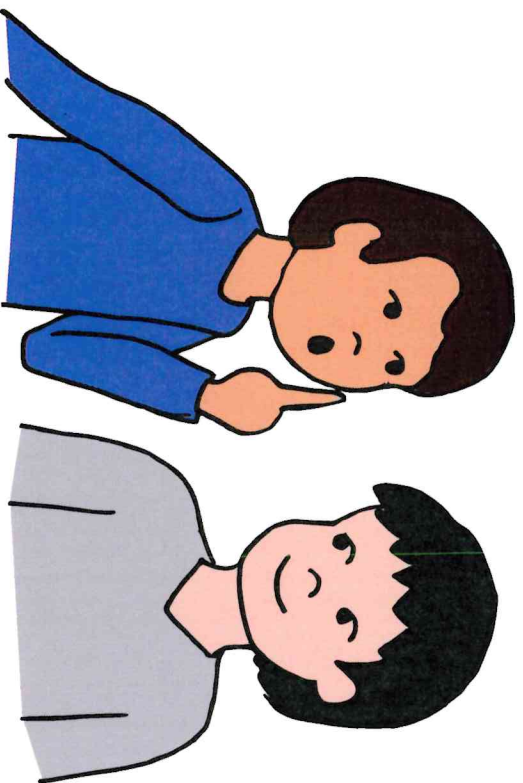

If a friend is talking,
we should remind them
to be quiet.

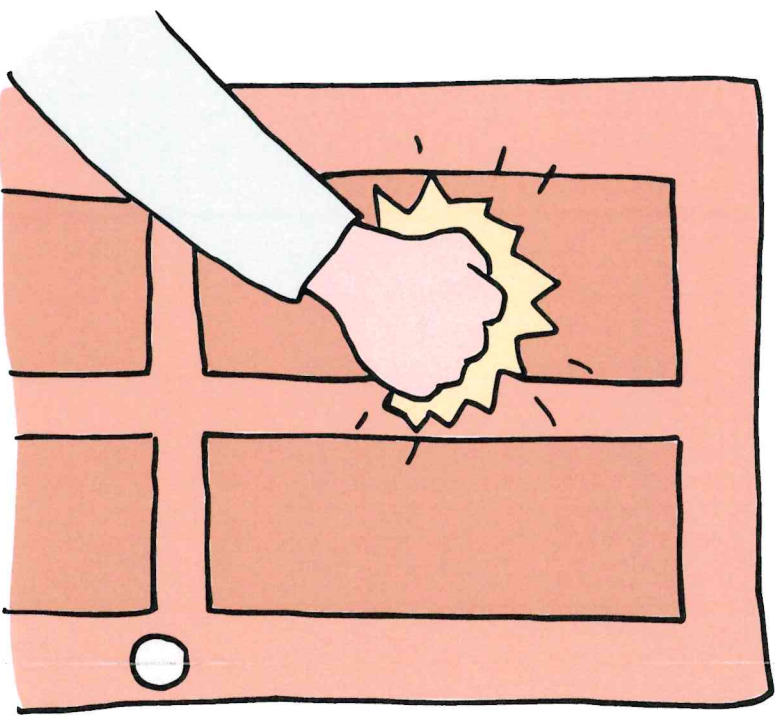

There might be banging
on our door.



It is not okay to open
the door during an
intruder alert, even if
someone is knocking.

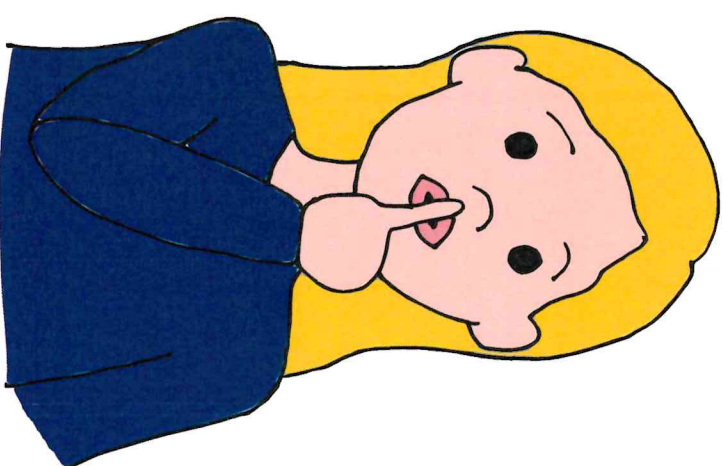

It might be noisy in the
hall, but we need to
stay quiet.

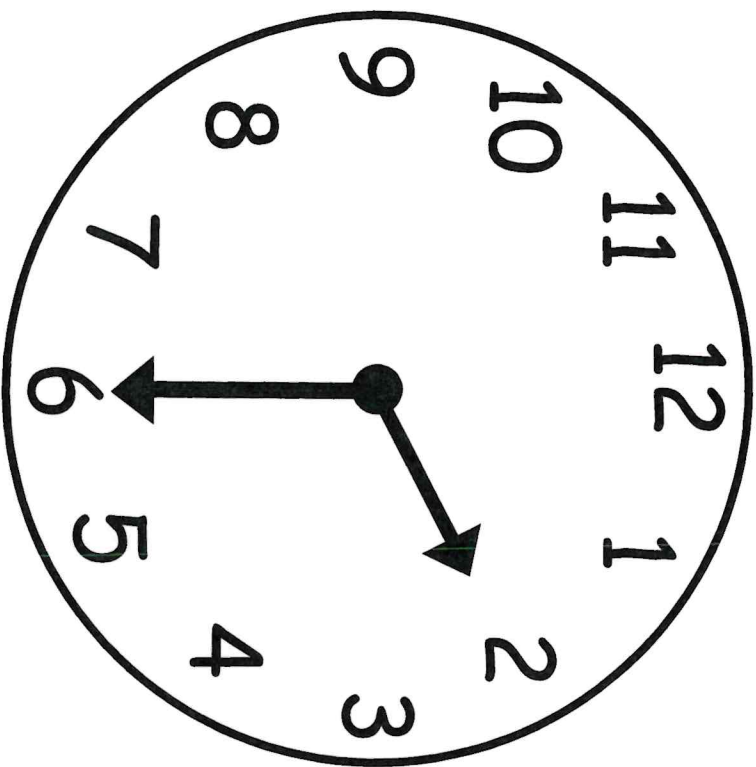

We don't know how long
it will take. We will have
to be patient.



Our classroom should
stay dark and quiet.

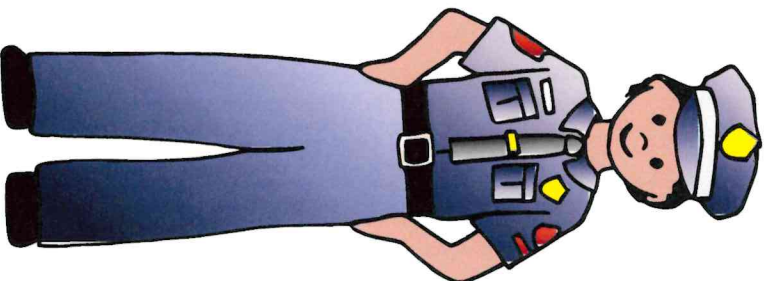

Police will come to our
school to help us.

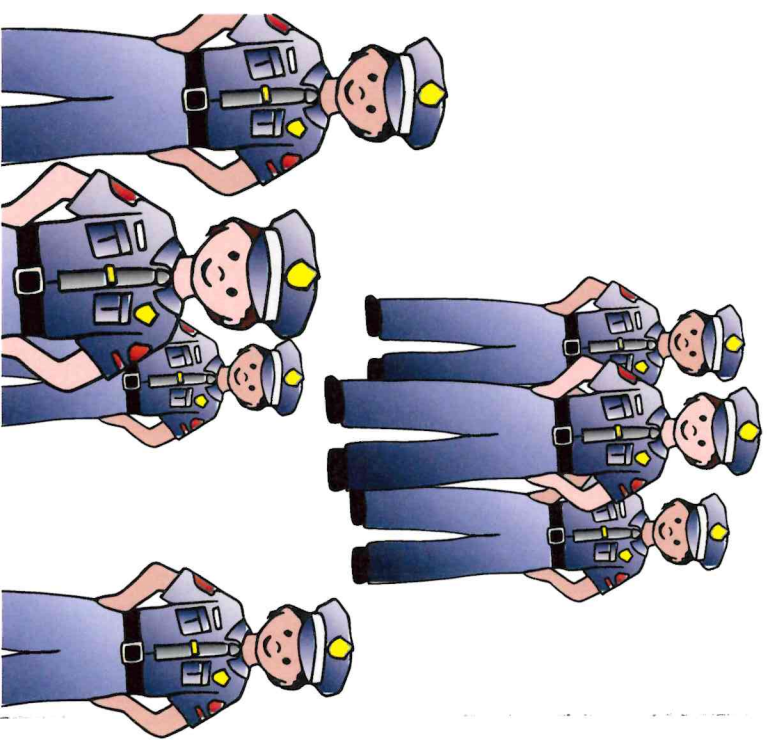

Police officers help
keep kids and adults
safe.



If a police officer
comes into our room, we
need to listen closely.

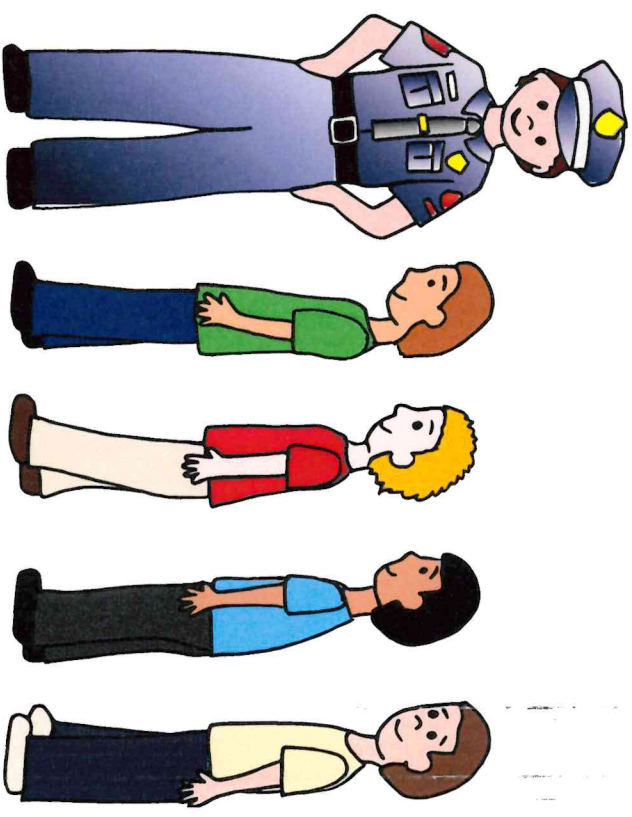

The police officer might
have us leave and go
somewhere else.

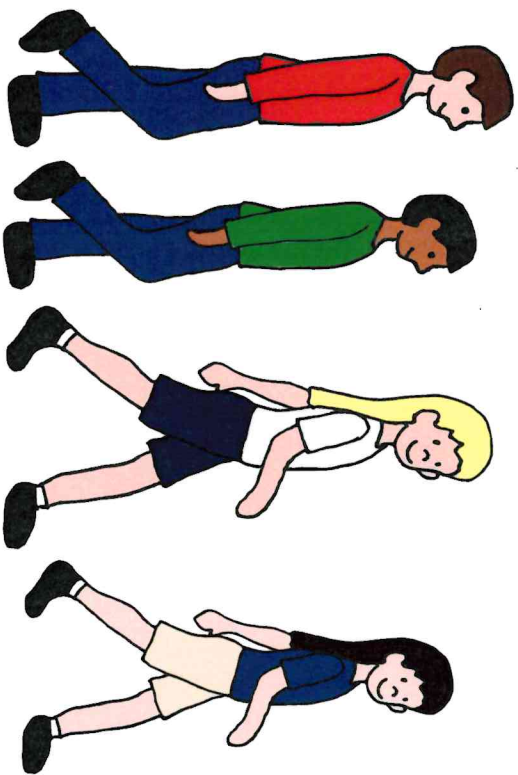

We should walk quietly
in a line and stay with
our class.



Police officers and
teachers are here to
keep us safe!



Our school can be safe during an intruder alert.

